



ASSEMBLY INSTRUCTION

ATALANTA CORNER LOUNGE ELECTRIC RECLINER LEATHER
ITEM CODE 83343

Imported by Amart Furniture Pty Ltd, Qld, Brisbane Australia.

For any assistance with assembly or for missing parts please phone Amart Furniture,
Customer Service Free call 1800 351 084

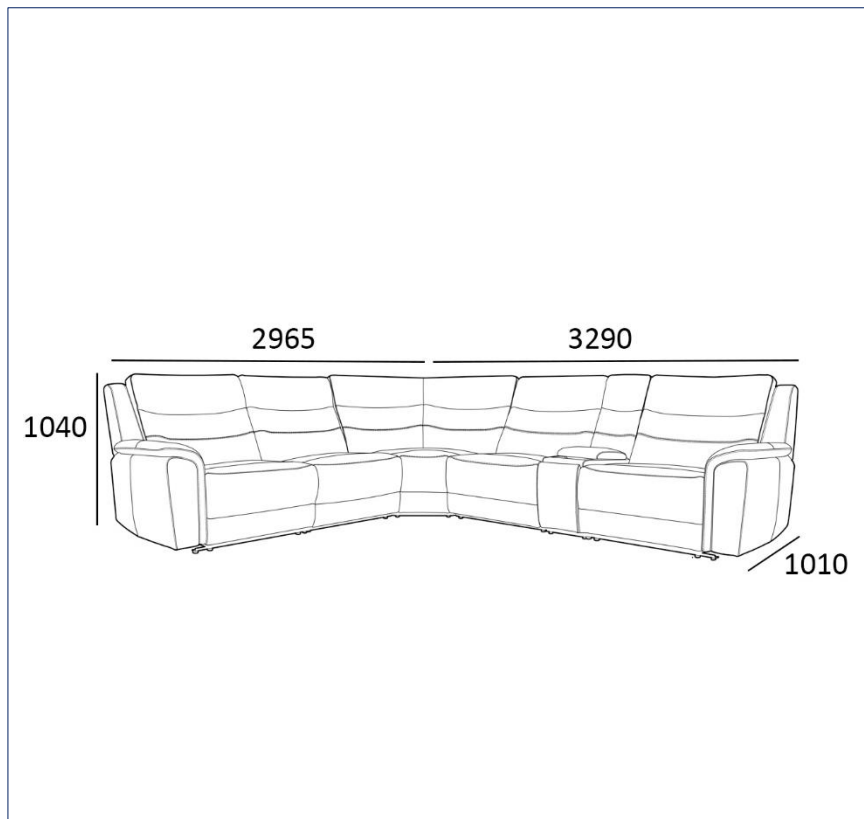



Imported by Amart Furniture Pty Ltd, Qld, Brisbane Australia.

For any assistance with assembly or for missing parts please phone
Amart Furniture, Customer Service Free call 1800 351 084

PRE-ASSEMBLY PREPARATION

Before you start:

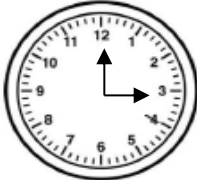
1. Choose a clean, level, spacious assembly area. Avoid hard surfaces that may damage to the product
2. Take care when lifting. Product should be assembled as near as possible to the point of use
3. Ensure that you have all required contents for complete assembly
4. Always read the assembly instructions carefully before beginning assembly.
5. Keep all hardware parts and packaging out of reach of small children.
6. Do not over tighten the screws and bolts as this may damage the threads

	
ALLOW 15 MINUTES	PEOPLE REQUIRED
NO TOOLS REQUIRED	
ADDITIONAL TOOLS REQUIRED	

WARNING

- Do not allow children to play on this mechanised furniture or operate the mechanism. Leg rest folds down on closing so that a child could possibly be injured. Always leave it in an upright and closed position. Keep hands and feet clear of mechanism. Only the occupant should operate it.

PARTS LIST

1	RIGHT RECLINER BACKREST
2	RIGHT RECLINER SEAT
3	ELEMENT BACKREST X2
4	ELEMENT SEAT X2
5	WEDGE BACKREST
6	WEDGE SEAT
7	TABLE ELEMENT BACKREST
8	TABLE ELEMENT BASE
9	LEFT RECLINER BACKREST
10	LEFT RECLINER SEAT
11	KD WING X2
12	WALL PLUG
13	Y-CABLE
14	SINGLE CABLE

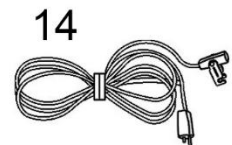
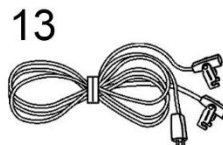
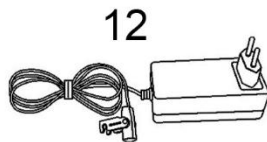
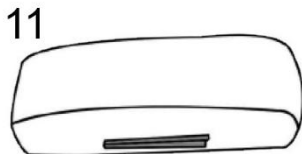
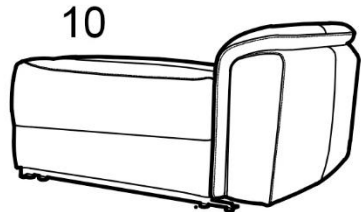
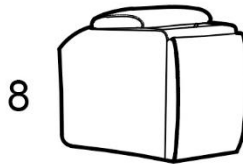
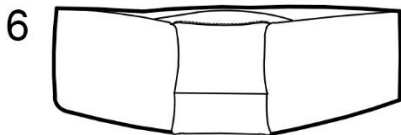
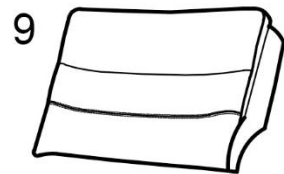
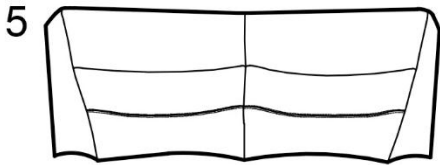
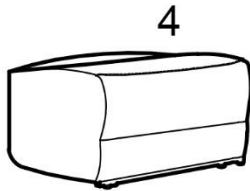
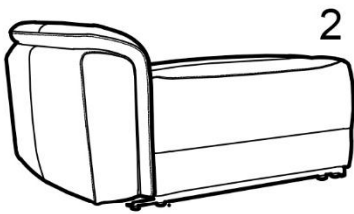
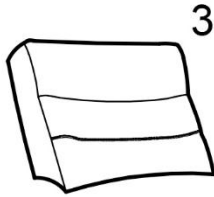
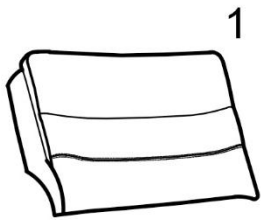

STEP 1:

Recliners wings assembly instruction

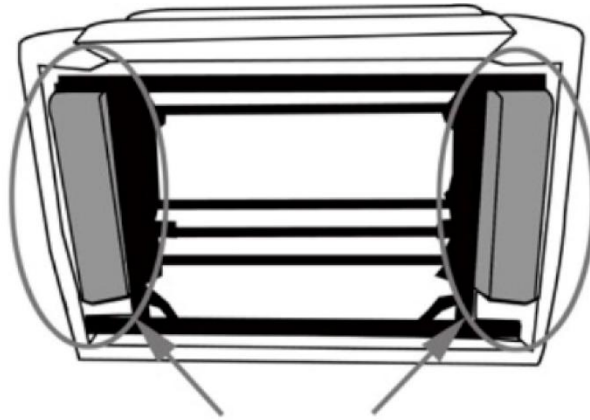

Wings are packed underneath the recliner

STEP 2:

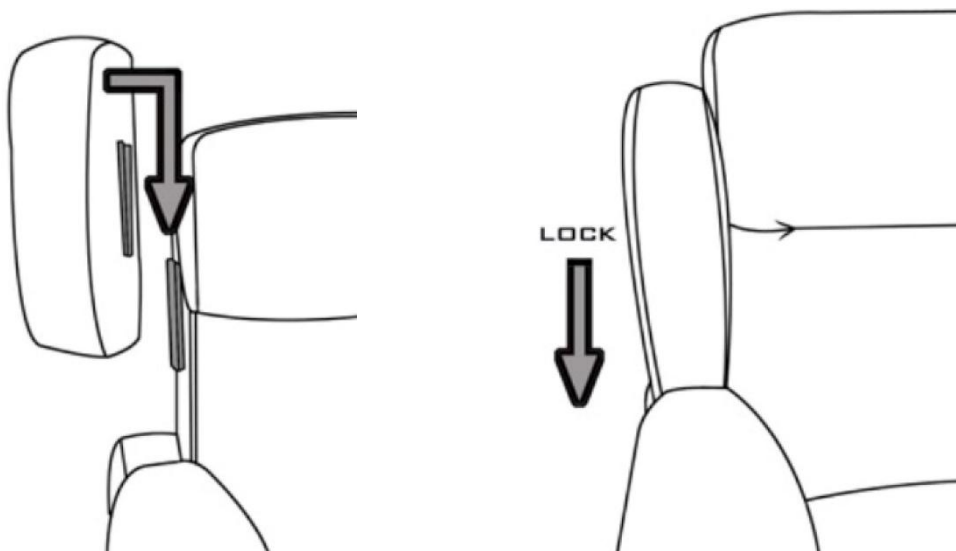

STEP 3:

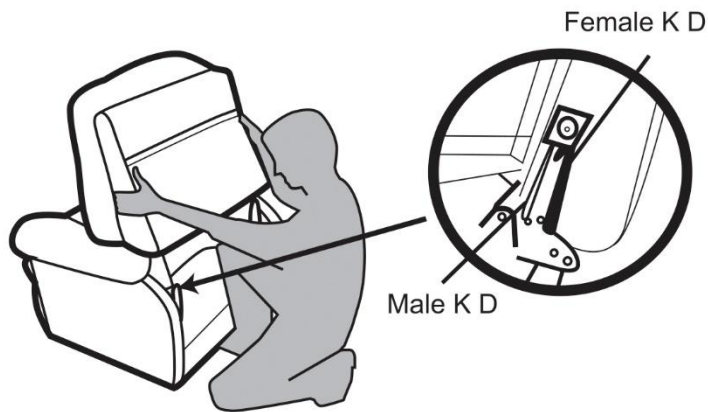

1. Rest the back frame on the arms of the chair.
This will give you a good view of the male and female KD brackets
2. Insert male KD bracket into the female KD bracket on one side to a depth of 5-10mm
3. While keeping the backrest leaned forward, insert male KD bracket of the other side into female KD bracket to 5-10mm

STEP 4:

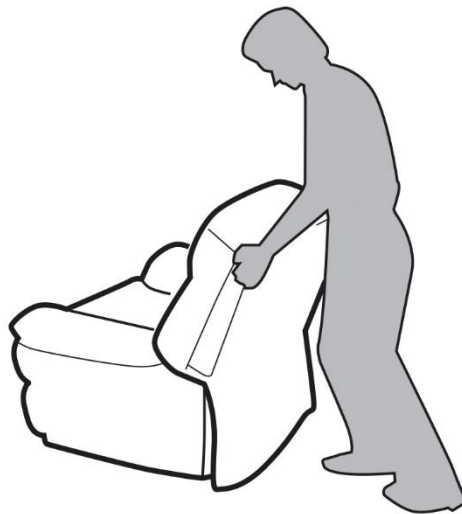

1. Straighten the backrest to a vertical position and lower the backrest evenly on both side to the position that rests on the top edge of the lock
2. Push on the top of the back rest to lock the bracket into position

STEP 5:



Pull the bottom of the back cover to the base of the chair and tape it along the Velcro.

STEP 6:

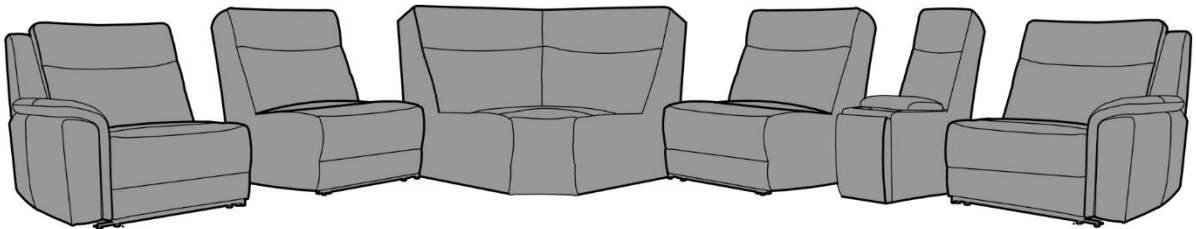

Repeat step 3 to step 5 to all individual unit.
Your corner sofa are now ready to be joined together.
Line up the units, ensuring all cables are out of the way.

STEP 7:



To link the units together always start the process from Linking left to right.
Lift and line up the linking pegs on the second unit with the slots on the first unit and lock into position.
Note Step 8 for visual detail of the linking bracket.

STEP 8:

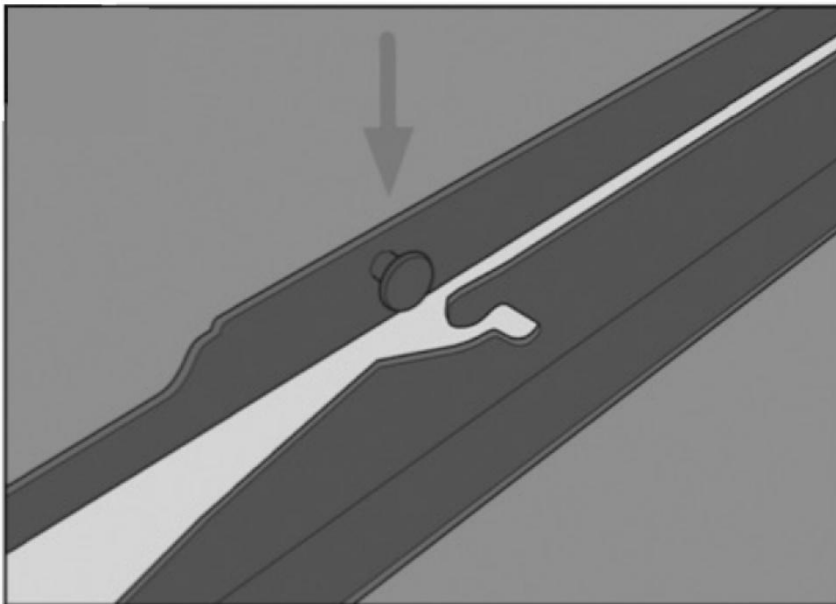

Linking brackets.

STEP 9:



Repeat step 7 for the rest of the unit.

STEP 10:

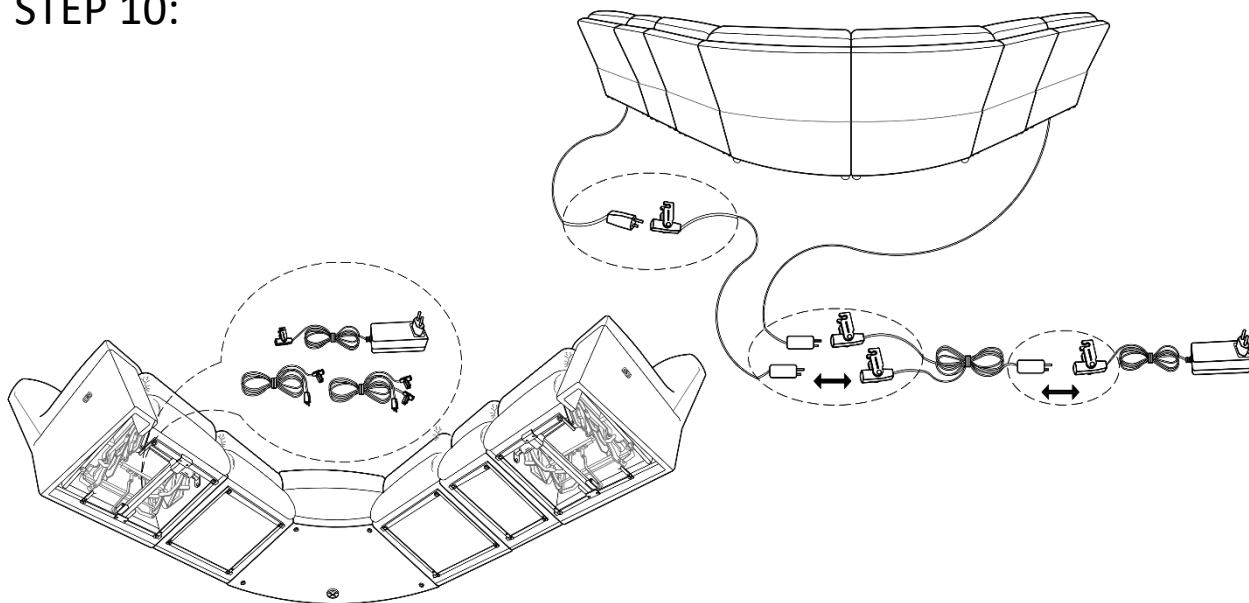

1. Power plug , single cable and Y-cable can be found in left hand facing recliner bottom.
2. Connection with power cable & power plug.

IMPORTANT NOTE:

PLEASE ENSURE THAT ALL ELECTRICAL CORDS AND CABLES ARE CLEAR OF THE FRAME AND MECHANISM. FAILURE TO DO SO MAY SEVER YOUR POWER CORD RESULTING IN SERIOUS INJURY OR DEATH.

SAFETY NOTE

WARNING! AVOID POTENTIAL EQUIPMENT DAMAGE OR ELECTRIC SHOCK! DO NOT PLACE THE TRANSFORMER UNDER OR WITHIN THE RECLINER STRUCTURE.

DO NOT COVER THE TRANSFORMER. KEEP IT IN AN OPEN, WELL-VENTILATED AREA FREE FROM FOREIGN MATERIAL/DEBRIS TO ENSURE PROPER OPERATION.

STEP 9:

1. Your sofa should now recline.
2. Refer to below diagram on how to use the switch.

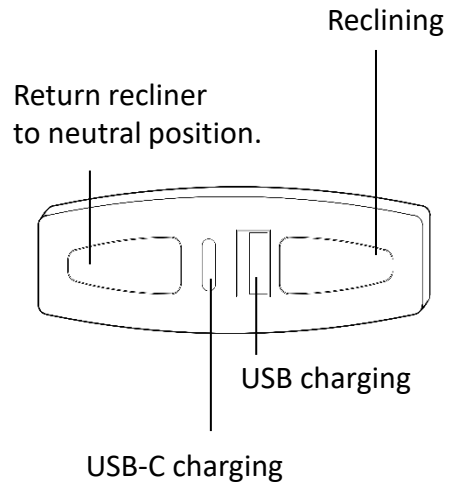

ASSEMBLY IS COMPLETE

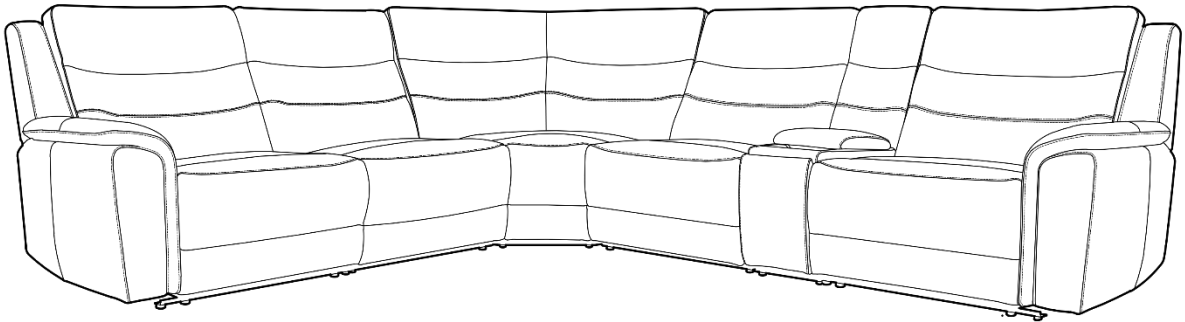

READ THESE INSTRUCTIONS THOROUGHLY BEFORE USE:

DANGER: TO REDUCE THE RISK OF ELECTRIC SHOCK:

Always unplug from electric outlet before cleaning.

Always place transformer well away from recliner mechanism base.

WARNING: RISK OF INJURY

Keep children away from extended footrest and any moving parts.

CAUTION: Do not allow children to play on this electric recliner or operate the powered mechanism.

The leg rest folds when closing and could possibly cause injury to a child.

Always leave the recliner in an upright and closed position when not in use.

Keep hands and feet clear of mechanism. Only the occupant should operate it.

Keep pets away from underside of recliner.

POWER CORD SAFETY

WARNING: Unplug and remove power cord from wall when not in use and store out of reach of children.

Take care when moving recliner that wall and transformer cords are not under the base or they may get damaged.

NEVER OPERATE ELECTRIC RECLINER IF IT HAS A DAMAGED CORD OR PLUG.

WARNING: TO REDUCE RISK OF BURNS, FIRE, ELECTRIC SHOCK OR PERSONAL INJURY TO

PERSONS:

- Use only for its intended purpose.
- Never press or activate control switch if you are not seated in recliner.
- Only the occupant should activate the control switch.
- Never operate with more than one person occupying seat.
- Never sit or stand on the footrest.

READ THESE INSTRUCTIONS THOROUGHLY BEFORE USE:

It is crucial to handle your reclining sofa with care. Following the intended usage guidelines will ensure safety and product longevity.

Recliners have a metal mechanism base, with moving parts to allow reclining functions. These components are flexible but can be easily bent or twisted if subjected to excessive weight, improper use, or excessive motion.

Safety

Moving parts; particularly reclining mechanisms can be dangerous if used incorrectly:

- ALWAYS supervise children when they are around or on reclining furniture. Prevent them from operating the mechanism or playing on the recliner.
- Only the occupant should operate the recliner. When not in use, ensure it is returned to the lounges closed position.
- When closing the recliner-
- Always check underneath the mechanism to ensure that the footrests are folded down properly.
- Avoid placing hands and feet near the mechanism.
- Be mindful of children and pets, and the possibility of trapping items like clothing or blankets in the mechanism.

It is recommended that the closing motion be closed slowly.

General Care

It is crucial to use recliners carefully and in accordance with their intended design to maintain their structural integrity. Misuse of the reclining mechanism can lead to bending or bowing. All Amart sofas have a weight capacity of 120kg per seat.

- Always ensure that footrests are fully closed before entering or exiting the seat. Using the seat with the footrest open can damage the structure and is not the intended usage.
- While reclined, the footrests are designed to support the weight of a single person's feet. Excessive weight, especially from pets and children, can overload the mechanism and cause twisting and bowing.
- Avoid leaning on the sides of the recliner at any time. Reclining seats are designed to be sat on in the middle as the centre of the cushion provides structural support. Leaning over the sides of the seat can twist the mechanism.
- Ensure that when you close the mechanism that equal weight is placed on the centre of the footrest panel. Do not close from the edges of the recliner's footrest. This causes stress on the mechanism and leads to a broken and bent mechanism. This is not a manufacturing fault but a result of improper use.

Positioning your recliner

It is imperative that you ensure your recliner is positioned on a level surface to ensure its longevity.

Positioning your recliner on an unlevel or sloping surface can put additional strain on the internal components of your recliner.

The internal components of the recliner, such as the frame, levers, and hinges may experience increased stress if the recliner is constantly used on an uneven surface. Over time, this leads to premature wear and tear, affecting the recliner's durability, stability, and performance.

Additional issues that can impact electric recliners if positioned on an unlevel floor are as follows:

- 1. Motor strain** – The motor in an electric recliner is designed to operate under conditions where the load is evenly distributed. When the floor is not level, the motor works harder to adjust the recliner, leading to increased wear and tear over time.
- 2. Uneven Movement** – An electric recliner on an uneven floor may not operate smoothly or evenly. This can result in jerky movements, uneven reclining, or difficulty in adjusting the position, potentially causing discomfort for the user.

Moving your recliner?

- Always ensure that the recliner is upright when transporting.
- Moving or transporting reclining sofas can be challenging due to their weight, which includes the mechanism and frame. Always ensure there are at least two people to lift the weight properly and avoid dragging or dropping the recliner as it can cause bending and bowing of the mechanism.
- Do not pull your sofa by the cushions and fabric as this will result in tears and rips.

Product Care for Leather Items

When necessary brush or vacuum away dust and grit. Wipe over with a soft, clean, colourfast cloth

FOR SPOTS AND SPILLS:

- Wipe excess liquid up immediately with an absorbent cloth or sponge

FOR OVERALL CLEANING:

- We recommend cleaning every 3-4 months with leather cleaner followed by applications of leather protector
- Always follow directions on packs

NOTES:

- Accumulation of perspiration and body oils on arm pads, headrests, etc. may damage your leather. These areas may require more frequent cleaning
- Leather is not recommended for users on frequent medication. Particularly heart, blood pressure, diabetes or chemotherapy medication. This medication can seep through the skin and when combined with perspiration, attacks the protective polyurethane coating of the leather
- Leather is a natural product and any stress may result in tears. Additionally when stretched the leather might not completely return to its original shape. Therefore when leather is used more intensively it may become loose over time
- If cushions are sewn to the frame, any pulling or tugging might result in a tear. Please avoid any leaning, sitting or reaching over the back/arms of the sofa
- To keep your cushions looking fluffy and new, use seating evenly
- Leather is not resistant to animals. Allowing pets on your leather is not recommended. Their claws and jaws may scratch the covers, which can lead to expensive repair. Their saliva is acidic and may also harm the leather finish

DO NOT:

- Dry clean or machine wash
- Expose leather to direct sunlight, intensive heat, weather or soak unnecessarily. Always avoid excessive hard rubbing
- Use saddle soap, detergents, solvents, abrasives, unidentified leather cleaners, suede cleaners or any products containing silicon or solvents
- Use silicone based leather care products. These can damage the coating over time. Any leather care product with an oily or greasy feel should be avoided
- Expose leather to new clothing, cushions or throws as this may lead to dye transfer and permanent staining. Ensure these items are colourfast before placing them on the leather

General Product Care

To protect your furniture, we suggest the following:

- Avoid placing your furniture in direct sunlight.
- Do not place furniture directly under windows.
- Do not place sharp materials (knife, fork, etc.) directly onto your furniture as sharp material may scrape and damage the finish.
- Do not place material with high temperature directly onto the surface of your furniture.
- Clean up spills quickly. Water left over a prolonged period of time may cause damage. Alcohol, perfume, nail polishes, aftershave and some medication may cause severe finish damage if not cleaned immediately.
- Use a clean, soft, dry, lint free absorbent cloth to clean your furniture. Do not use any detergent as they may contain ingredients that may react and damage the finish.